

TEMPORARY ABUTMENTS



DITRON DENTAL USA



MPI™ IMPLANTS WITH TEMPORARY ABUTMENT & PLASTIC SLEEVE



ULT™ IMPLANTS WITH TEMPORARY ABUTMENT & PLASTIC SLEEVE

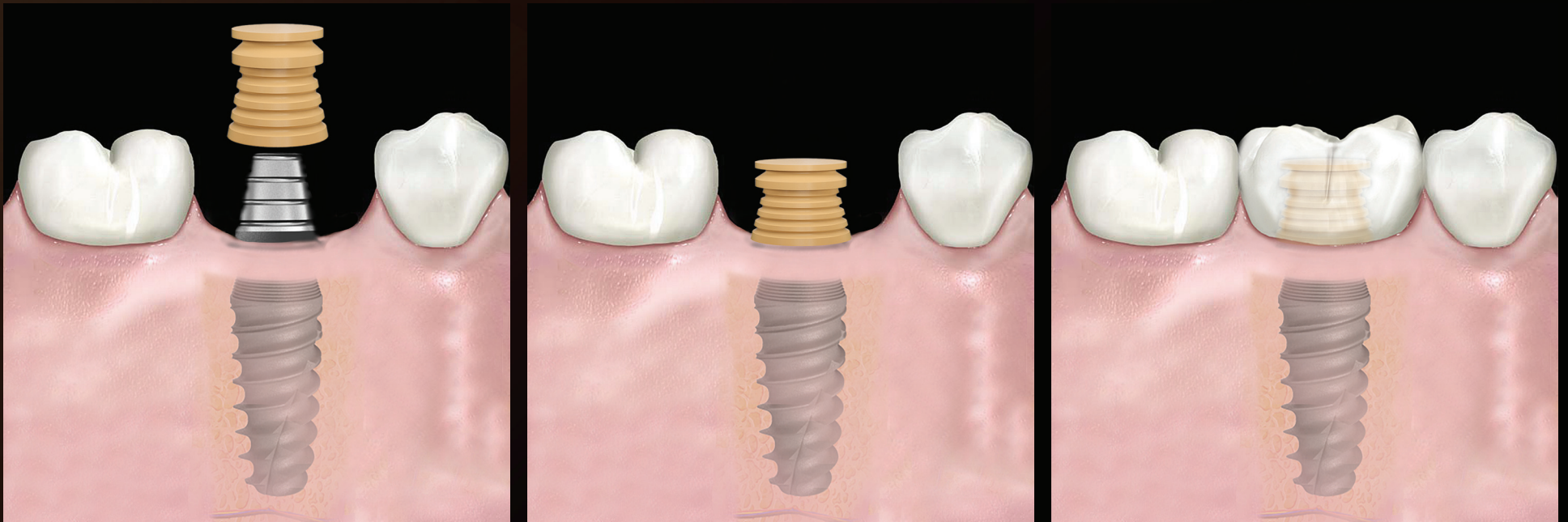

TEMPORARY ABUTMENTS & PLASTIC SLEEVES

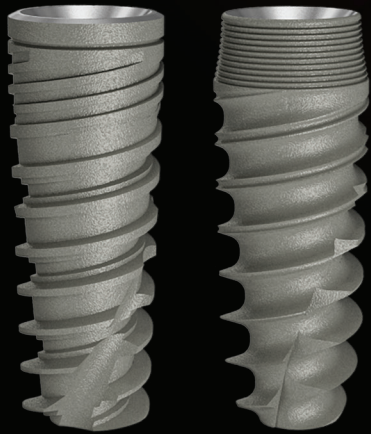
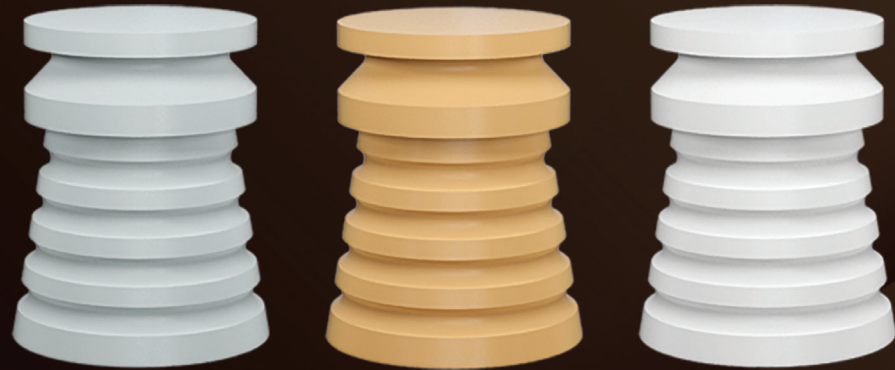

TAB-7008

ABUTMENT SCREW USES 1.25 MM HEX DRIVER

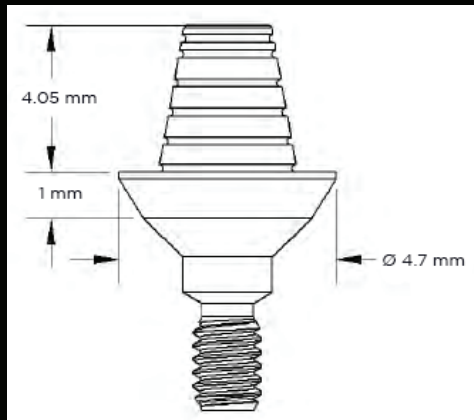

Ø 4.7 mm



TAB-7001



TAB-7002

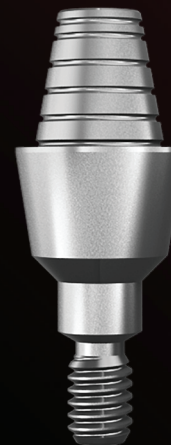

TAB-7003

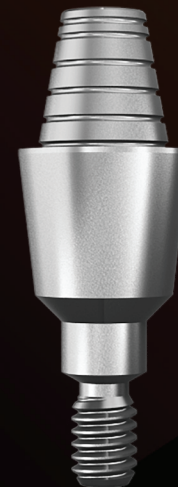

TAB-7004

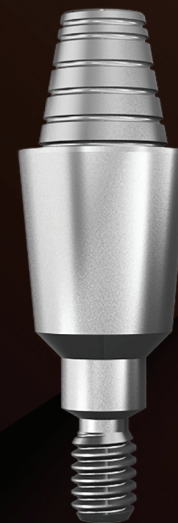

TAB-7005



TAB-7007

ORDER NOW

